

PORTABLE CD PLAYER WITH EXTERNAL SPEAKER

Item No: M879

Instructions for Use

Please read and retain these instructions for future reference

v001: 04/07/24

BERGSTRÖM

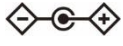

Specification:

Power Requirement:	5V DC (1.0A) USB-C (USB-C charging cable supplied) Built-in lithium-ion rechargeable battery (3.7V/1000mAh) AC Adaptor (not included): Input: AC 230V ~ 50Hz Output: DC 5V $\overline{\text{---}}$ 1000mA 
Speaker Output Power:	0.25W+0.25W (8 ohms, 1 kHz, THD 10%)
FM Receiver Frequency:	87.5 – 108 MHz
Bluetooth:	Version 4.0 & 5.0

Accessories: 1pc earphone and 1pc USB-C charging cable

Please read this instruction manual thoroughly before starting and ensure you are familiar with the operation of your new PORTABLE CD PLATER WITH EXTERNAL SPEAKERS.

- Play CD, CD-R, CD-RW, MP3 discs
- A-B Repeat function
- Anti-skip protection CD 60S /MP3 120S
- FM radio
- Bluetooth transmit
- LCD display
- Built-in lithium-ion rechargeable battery (3.7V/1000mAh)
- Earphone socket
- Input connectors: USB-C jack
- Speaker Output Power: 0.25W+0.25W (8 ohms, 1 kHz, THD 10%)

CAUTION

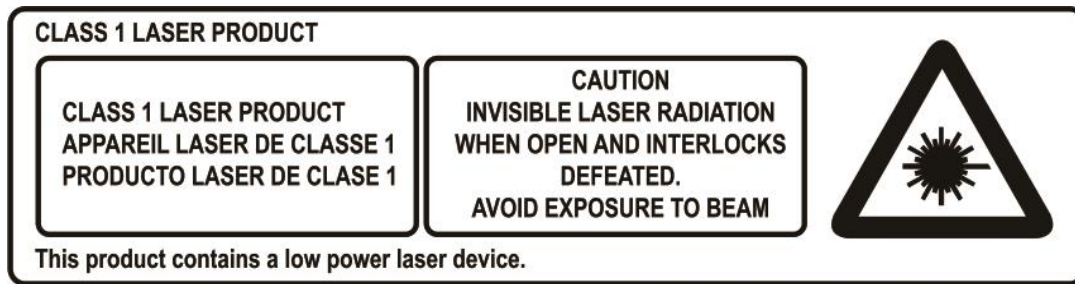

SAFETY

Before you use read the following safety instructions.

1. As the laser beam used in this compact disc player is harmful to the eyes, do not attempt to disassemble the casing.
2. Stop operation immediately if any liquid or solid object should fall into the cabinet.
3. Do not touch the lens or poke at it. If you do, you may damage the lens and the player may not operate properly.
4. Do not put anything in the safety slot. If you do, the laser diode will be ON when the CD door is still open.
5. This unit employs a laser. The use of controls or adjustment or performance of procedures other than those specified here may result in exposure to hazardous radiation.
6. If you do not follow the operating instructions provided, it may compromise the safety of your product, and this may invalidate the warranty.
7. Do not expose the product to dripping or splashing. Do not place objects filled with liquids, such as vases, on the product.
If liquid or water spills onto the product, switch it off immediately and contact your dealer.
If you are using a mains-powered adapter, do not touch the product with wet hands.
8. The internal battery in this product is not user replaceable. Do not expose the battery to excessive heat or naked flames. Ensure adequate ventilation and airflow around the product, particularly when charging. Dispose of the product in accordance with local environmental rules.
9. Using the product in rooms or climates with high humidity and temperatures may cause condensation to form inside the product, which can damage the product. Use the product in moderate climates only.
10. Do not use your product in extremely hot or cold temperature. Keep the device away from heat sources, such as radiators or gas/electric fires. Do not expose your product to naked flames, such as lighted candles.
11. To charge your product, only connect it to a supply source that meets the safety, isolation requirements of EN 62368 or EN 60950-1 for an accessible safety extra low voltage circuit. For this connection, use either the supplied USB Type C cable or a suitably CE approved power adapter with the correct USB output rating.
12. Power the product using an external 5V DC 1A power supply. The maximum output current is 1A, protected by an internal circuit.
13. Before you charge your product, ensure that the available supply voltage corresponds with the required operation al voltage of the product.
14. Disconnect your product from the charging power supply if you will not use your product for a long period of time (for example, if you are going on holiday).
15. Always unplug your product from the charging power supply before cleaning. When cleaning the product, do not use any type of abrasive pad or abrasive cleaning solutions as these may damage the product's surface.

16. To reduce the risk of electric shock, do not remove any screws. The product does not contain any user-service able parts inside. Product repairs should only be carried out by authorized personnel.

To prevent possible hearing damage, do not listen at high volume levels for long periods of time. Consistent exposure to high volumes when using headphones can damage your hearing. Always check the volume level before you insert headphones into your ears. Use of headphones other than those supplied may expose you to hearing damage, as the high level volume warning on the device may be in accurate. Use of headphones while operating a vehicle is not recommended and is illegal in some areas. If you find that listening to is distracting while operating any type of vehicle or performing an activity that requires your full attention, stop listening.



LOCATION OF CONTROLS

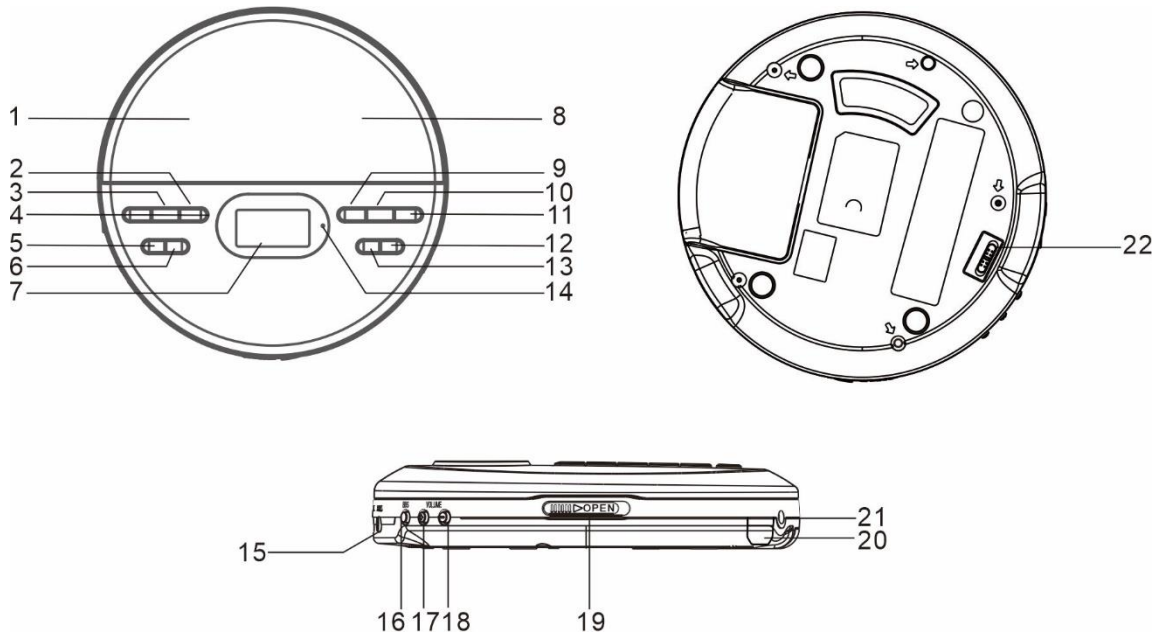

1.	L- SPEAKER	12.	FM PRESET- BUTTON FOLDER- BUTTON
2.	MODE BUTTON	13.	FM PRESET+ BUTTON FOLDER+ BUTTON
3.	BUTTON POWER OFF BUTTON CD STOP ■ BUTTON	14.	BATTERY CHARGING INDICATOR
4.	POWER ON BUTTON CD / ▶ BUTTON	15.	EARPHONE JACK
5.	◀◀ / TUNER- BUTTON	16.	EQ/BBS ON/OFF BUTTON
6.	▶▶ / TUNER+ BUTTON	17.	VOLUME + BUTTON
7.	LCD DISPLAY	18.	VOLUME – BUTTON
8.	R- SPEAKER	19.	CD DOOR OPEN SWITCH
9.	CD PLAY MODE BUTTON PROGRAM BUTTON	20.	USB-C JACK
10.	BLUETOOTH TX	21.	DC IN JACK
11.	A-B BUTTON FM SCAN BUTTON	22.	HOLD SWITCH

POWER SOURCE

Built-in Lithium Battery

This unit operates on a built-in Li-ion battery that can be recharged either by using DC 5V, 1A USB charger (not included) or from an AC adaptor (not included) with a rated output of DC 5V, 1000mA. The internal battery may not be fully charged out of the box, even if the Red charging LED turns off. We recommend that you charge at least 5 hours before first use.

Note: The Type-C USB and DC IN jack are located on the right hand side of the unit. They are designed for charging the internal Li-ion battery. The unit will still operate while charging, but doing this may reduce the battery life and increase the charging time.

LOW BATTERY INDICATOR

When using battery power to operate this unit and the battery power becomes weak, the “” icon will show on display. You are recommended to charge the rechargeable battery.

Note:

1. After prolonged use, the battery voltage will discharge and operation might become intermittent. When this happens, please recharge the internal battery.
2. Charging time will be vary if you are listening to music while charging the unit battery. We recommend you turn off the unit power during the charging process or until the unit battery is fully charged.
3. To prolong the life of a rechargeable battery, it is recommended to completely discharge it before fully charging it again.
4. Rechargeable batteries need to be cycled for maximum performance and longer battery life. If you don't use the player that often, be sure to recharge the battery at least once a month in order to keep the internal battery working properly.



BATTERY NOTE AND CARE

- Do not burn or bury batteries.
- Do not puncture or crush.
- Do not disassemble.
- Recycle Li-ion batteries. Do not dispose of in the trash.
- Use only chargers rated for Li-ion cells. Be sure the charger's voltage and current settings are correct for the battery pack being charged.
- Charge batteries on a fireproof surface away from flammable items or liquids.
- Batteries should NEVER be left unattended while charging. Only adults should charge the batteries.
- Follow the manufacturer's instructions for charging the product and do not charge longer than recommended. Unplug the charger when the battery is charged or not in use.

CHARGING THE BATTERY USING THE TYPE C USB PORT

1. Charge the built-in Li-ion battery a minimum of 5 hours prior to first use.
2. Use the included charging cord, and plug the USB power adaptor (not included).
3. The Red charging LED located on the top panel will light. It will turn off when the battery is fully charged.
4. Unplug the USB to USB-C cable from the power source once the battery is fully charged.

NOTE

1. You can use a USB AC adaptor with an output current of 500 mA or computer USB port as well, but it may take a very long time (10 hours or more) before charging completes. When using such a USB AC adaptor, it's recommended that you turn off power before charging the battery.
2. Use of a USB AC adaptor with an output current of less than 500 mA is not guaranteed for battery charging.

CHARGING THE BATTERY USING THE AC/DC Adaptor (Not included)

Use an AC adaptor with output DC 5V \approx 1000mA.

1. Plug the AC adaptor (not included) into normal AC power outlet socket.
2. Insert the DC plug of the AC adaptor cord into the DC IN JACK.
3. The Red charging LED located on the top panel will light. It will turn off when the battery is fully charged.
4. Unplug the AC adaptor once the battery is fully charged.

WARNING: Before connecting to the power supply, ensure that the supply corresponds to the information on the rating label of the apparatus.

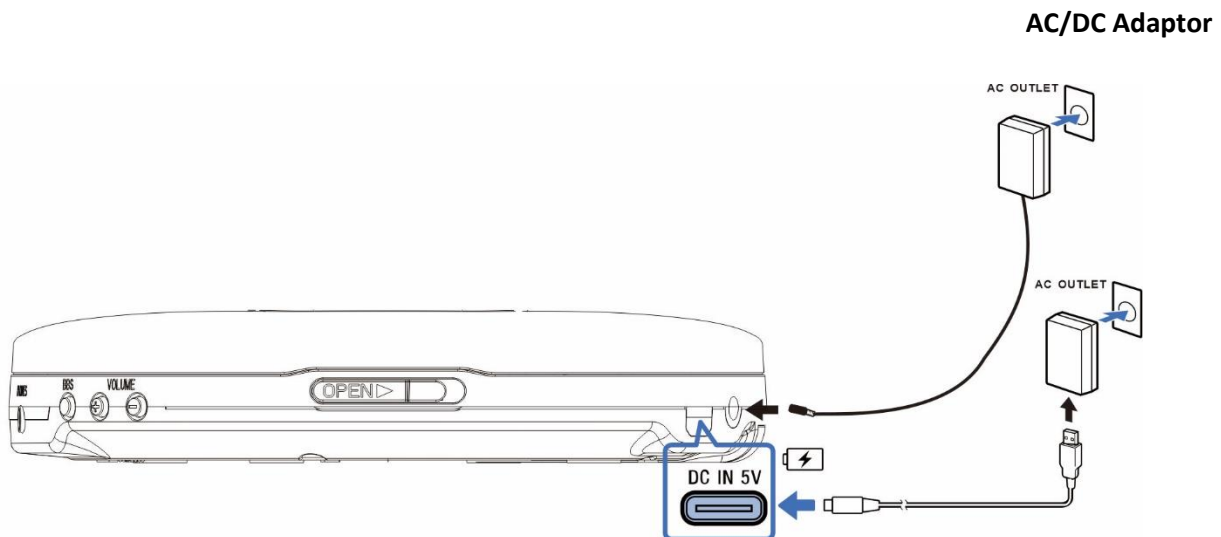

EARPHONES CONNECTION (PLUG-IN TYPE)

Connect the plug of the stereo earphone (included) into the EARPHONES JACK (#15).

CAUTION

- Avoid excessive volume levels for long period of time when using the earphones. Prolonged use at high levels may impair your hearing.
- Do not use earphones while operating a motorized vehicle, as it may create a traffic hazard and is illegal in many areas.

CD OPERATION

PLEASE READ THIS IMPORTANT INFORMATION:

CD mechanisms used in devices like this are designed to fully read all commercial CDs. They will also read self-compiled CD-R/CD-RW discs but it may take up to 10 seconds for playback to start. If playback does not start, it is likely due to the quality of the CD-R/RW disc and/or the compatibility of the CD compilation software. Manufacturer is not responsible for the playback quality of CD-R/RW discs.

Do not attach a label or seal to either side of the CD-R/RW disc. It may cause a malfunction.

1. Make sure the HOLD switch (#22) located on the bottom of the unit is set to OFF position. Press and hold the POWER ON BUTTON (#4) to turn on the unit.
2. Press and hold the MODE BUTTON (#2) to enter CD mode if necessary.
3. Slide the CD DOOR OPEN SWITCH (#19) to open the CD door. Carefully place an audio CD with its label side upward in the CD compartment and close the CD door.
4. The player will start reading TOC of the disc and display showing "READ" during CD loading.
5. The total number of tracks and time on the CD will appear on the LCD DISPLAY (#7) after a few seconds.

Note: Display will show total number of folders and tracks on MP3 CD.

6. Tap the ►|| BUTTON (#4) to start to play.
7. Press the VOLUME +/- BUTTONS (#17/18) to obtain the desired sound.
8. To pause the CD, tap the ►|| BUTTON (#4) again. To resume playing, tap the ►|| BUTTON (#4) again.
9. You can choose to play your favorite track directly by pressing either the ►| or |◀◀ BUTTONS (#5 or #6) repeatedly. The LCD Display (#1) will indicate the correct track number selected.
10. To locate a particular passage within a track, press and hold the ►| or |◀◀ BUTTONS (#5 or #6) until it is found.

Note: Low level audio will be heard during the search process to assist in locating correct point in the track.

11. To repeat a particular track, tap the PLAY MODE BUTTON (#9) repeatedly until the REP 1 indicator lights on the LCD DISPLAY (# 7).
12. To repeat the entire CD, tap the PLAY MODE BUTTON (#9) repeatedly until the REP ALL indicator lights on the LCD DISPLAY (# 7).
13. Tap the PLAY MODE BUTTON (#9) repeatedly until the RANDOM indicator light on the LCD display to play songs randomly.
14. Tap the PLAY MODE BUTTON (#9) repeatedly until the INTRO indicator light on the LCD display to play first 10 seconds of each song.
15. When playing a MP3 CD, tap the PLAY MODE BUTTON (#9) repeatedly until the REP DIR indicator light on the LCD DISPLAY (#7) to repeat playing songs in the folder.
16. To stop playing, tap the STOP ■ BUTTON (#3).
17. Press and hold the POWER OFF BUTTON (# 3) to turn off the unit.

NOTE:

The unit will automatically go into power saver mode and turn off if the CD player is stopped for longer than 2 minutes.

If you're listening to the player at volume level 8 or higher and turn the unit off, the volume level will reset to level 8 when the unit is turned on again.

If you're listening to the player at volume level 7 or lower and turn the unit off, the volume will be at the same level when the unit is turned on again.

FOLDER UP (MP3 CD only)

Tap the FOLDER+/- BUTTON (#12/#13) repeatedly to select MP3 CD folder location in the upward direction.

PROGRAM OPERATION

This function allows the tracks to be played in a programmed sequence. Programs can be set in STOP mode.

1. Tap the PROGRAM BUTTON (#9) once. The track number "T-01" and Program Channel Number "P01" will appear on display. "01" of the track number will blink on the LCD DISPLAY (#7) to prompt for input.
2. Tap the ►► or ◀◀ BUTTONS repeatedly (#5 or #6) to select the track to be programmed.
Note: Tap the FOLDER+/- BUTTON (#12/13) button to select next MP3 folder if you are programming tracks of a MP3 CD. Tap the FOLDER+/- BUTTON (#12/13) button repeatedly to cycle the folder selection.
3. Tap the PROGRAM BUTTON (#9) again to store selection. The Program Channel Number will change to "P02" and the track number keeps blink to prompt for input the next track to be programmed.
4. You may repeat steps 2 - 3 to program up to 24 tracks.
5. Tap PLAY/PAUSE ►|| BUTTON (#4) to start the programmed play, "PROG" icon appears on the LCD display.
6. You may repeat the current programmed track or all programmed tracks by pressing the PROGRAM BUTTON (#9) once or twice at programmed play mode.
7. Tap STOP ■ BUTTON (#3) once to stop playback.
8. Tap PLAY/PAUSE ►|| BUTTON (#4) to resume programmed play.
9. To cancel programmed play and, press the STOP ■ BUTTON (#3) twice.

A-B REPEAT PLAYBACK

1. During playback, press REPEAT A-B BUTTON (#11) at the point where you want to start playing repeatedly.
Repeat A- is displayed on the LCD display (#7).
2. Press REPEAT A-B BUTTON (#11) at the point where you want to stop playing repeatedly.
Repeat A-B is displayed on the display (#7) and the specified section (point A to point B) is played back repeatedly.
3. Tap the STOP ■ BUTTON (#3) to clear the A-B repeat playback setting and stop playback.

RADIO OPERATION

1. Press and hold the POWER ON BUTTON (#4) to turn on the unit.
2. Press the MODE BUTTON (#2) to enter FM mode if the unit is in CD mode. "FM" will appear on the LCD DISPLAY (#7) along with the current FM radio station frequency.
3. To automatically scan and store radio stations, press and hold the SCAN BUTTON (#11) until frequency readout on the display begins to scan and then release the button.
4. To manually tune to a specific radio station, tap the TUNER- or TUNER+ BUTTON (#12 or #13)

repeatedly. Use the manual tuning method to tune in weaker stations that are bypassed during Automatic Tuning.

5. To automatically tune to the next available radio station, press and hold the TUNER- or TUNER+ BUTTON (#12 or #13) for 1-2 seconds until frequency readout on the display begins to scan and then release the button. The tuner will stop scanning when it receives the next broadcasting station of adequate signal strength.
6. Press the volume control VOLUME +/- BUTTON (#17/#18) to the desired volume level.

FM / FM STEREO OPERATION:

If a stereo broadcast program is being received, the FM STEREO INDICATOR "ST" will appear on the display. During FM or FM Stereo reception, always keep the earbuds wire fully extended for best performance. However, if FM reception is weak, try repositioning the unit near an open window until you get the best reception.

TIPS FOR BEST RECEPTION

The cord of the earbuds acts as an antenna for the radio and must be fully extended for best reception.

PRESET RADIO STATIONS

1. Press and hold the POWER ON BUTTON (#4) to turn on the unit.
2. Press the MODE BUTTON (#2) to enter FM mode when the unit is at CD mode, the FM radio frequency appear on the LCD DISPLAY (#7)
3. Tune to the desired radio station either by "manually" or "automatically" tuning method.
4. Tap the PROGRAM BUTTON (#9), the preset memory number flash on the LCD DISPLAY (#1). (Note: P01 will blink in the display if you are programming preset for first time).
5. Tap the PRESET+/- BUTTON (#12/13) repeatedly to select the preset number you want to assign the station to.
6. Tap the PROGRAM BUTTON (#9) to confirm the setting.
7. Repeat above steps 3 - 6 to preset up to 30 FM stations.

NOTE:

This unit features an AUTO SEARCH function that will automatically save the first 30 strong stations found. To use this feature, make sure the unit is in FM mode. Press and hold the SCAN BUTTON (#6) until the station frequency begins to scan. The unit will scan from the lowest frequency to the highest frequency within the frequency band. The first strong radio stations found will be stored in the preset locations starting from P01. This will continue storing P02 and up until all 30 presets are stored, or until it runs out of stations to scan.

RECALLING PRESET RADIO STATIONS

Press the PRESET+/- BUTTON (#12/13) repeatedly to select the location of the station you want to listen to.

BLUETOOTH TRANSMIT MODE

The M879 has a built-in Bluetooth transmitter that allows you to wirelessly stream to Bluetooth compatible devices like speakers, headphones or earbuds. Follow the steps below to connect to a Bluetooth device and stream your favorite CDs to that device.

PAIRING WITH A BLUETOOTH DEVICE (SPEAKERS, HEADPHONES OR EAR BUDS)

1. Press and hold the MODE BUTTON (#2) to enter CD mode (CD stopped).
2. Make sure the Bluetooth device to you want to stream to is ON and set to pairing mode.
NOTE: For best results, have the Bluetooth device as close as possible or within 3 feet of the **M879** when pairing.
3. Press and hold the BLUETOOTH TX BUTTON (#10) to switch to Bluetooth Search Mode. Release the BLUETOOTH TX BUTTON (#10) once "BT TX" shows on the LCD Display (#7)
4. The **M879** will search for the closest available Bluetooth device and automatically connect to that device.
5. Once Bluetooth pairing is successful, the display will change back to the CD screen and "TX" will be showing in the upper right the LCD Display (#7). This confirms the unit is transmitting Bluetooth.
NOTE: Please note that the pairing time could be longer when connecting with a device for the first time.
6. Press the PLAY / PAUSE BUTTON (#4) to start playing the CD and begin streaming. The music from the CD will be heard on the connected Bluetooth device.
7. If you move out of Bluetooth range (10m) with the **M879**, the "BT TX" indicator on the LCD Display (#7) will begin flashing. Move the **M879** or your Bluetooth device back within range and reconnect the Bluetooth device if necessary.
8. If you want to connect to another Bluetooth device, first turn OFF the power on the current device you are connected to.
9. Make sure the new Bluetooth device to you want to connect to is ON, set to pairing mode and placed near the **M879**.
10. Repeat Follow steps 3 – 7 to connect to the new Bluetooth device.

Notes:

- Bluetooth streaming is not available in FM radio mode.
- If Bluetooth speaker or headphone has been connected before turning off, it will automatically connect back to the previous one during next connection.
- If the CD player is stopped for approximately 120 seconds, the power will automatically turn off, so you may need to repeat the Bluetooth connection steps above to stream again.
- If you need to remove a previously connected device from the **M879** press and hold the A-B BUTTON (# 11) to disconnect it. Immediately turn off the Bluetooth device to prevent the **M879** from reconnecting to it.
- This model is compatible with Bluetooth versions 4.0 & 5.0. Please try your other Bluetooth speaker or headphone if it is unable to find by this model.
- This CD player may not connect to certain vehicle entertainment systems if the manufacturer requires a passcode during the connection process.

TURNING OFF BLUETOOTH TRANSMISSION

1. Press and hold the BLUETOOTH TX BUTTON (#10) repeatedly until "OFF" appears on the LCD Display (#7).
2. The Bluetooth transmitter is now off and no longer connected to any device.

BBS FUNCTION

1. Press and hold the BBS BUTTON (#16) to turn on the BBS to enhance the bass effect of the music. Display will show "BBS ON" once.
2. Press and hold the button again to turn off the BBS. Display will show "BBS OFF" once again.

Note: EQ will be reset to "FLAT" if you turn BBS ON/OFF.

EQ MODES

This unit provides 4 different EQ modes to enhance your listening experience. You can select the desired effect by tap the BBS BUTTON (#16) repeatedly in following sequence:

FLAT ➔ CLASSIC ➔ ROCK ➔ POPS ➔ JAZZ

Note: BBS will be off if you select EQ mode.

HOLD FUNCTION

To prevent accidental function changes during active use, this unit is fitted with a function hold. After the unit has been powered on and playing in CD or FM mode, slide the HOLD SWITCH (#22) to ON position. "HOLD KEY" message will show on the LCD display (#1) for 2 seconds when you press a key. Set the HOLD SWITCH (#22) to OFF position to unlock the hold function.

Note: Auto power off for saving battery power will not be affected by hold function.

RESETTING THE UNIT

If the unit experiences a power surge or electric shock, it is possible that the internal micro-controller may lock up and the unit will not respond to any commands from the panel controls. In this event, press and hold the STOP ■ / OFF button until unit turns off. Waiting for 30 seconds and then press and hold the STOP ■ / OFF button to turn on the unit again.

CARE AND MAINTENANCE

1. Clean your unit with a damp (never wet) cloth. Solvent or detergent should never be used.
2. Avoid leaving your unit in direct sunlight or in hot, humid or dusty places.
3. Keep your unit away from heating appliances and sources of electrical noise such as fluorescent lamps or motors.
4. If drop-outs or interruptions occur in the music during CD play, or if the CD fails to play at all, its bottom surface may require cleaning. Before playing, wipe the disc from the centre outwards with a good soft cleaning cloth.





TROUBLE SHOOTING GUIDE

SYMPTOM	POSSIBLE	SOLUTION
No Sound	Battery no power	Fully recharge the built-in rechargeable battery.
	Volume set at minimum	Increase Volume.
Noise or sound distorted on FM broadcast	Earphone cord is not extended	Extend earphone cord
Radio no sound	The unit is not in RADIO (FM) mode	Switch to FM mode
	The station is weak	Retune the station again
CD player will not play	Unit not in CD mode	Switch to CD mode
	CD is installed incorrectly	Insert CD with label side up.
	Battery becomes exhausted	Fully recharge the built-in rechargeable battery.
	It the CD is self-compiled, the media used may not be compatible with the player.	Use better quality blank media and retest.
CD skips while playing	Disc is dirty or scratched.	Wipe CD with clean cloth or use another disc.
	Dirty or defective disc	Clean or replace the defective disc
	Dirty pick up lens	Use a CD-lens cleaning disc to clean the lens
	Player is subject to excessive shock or vibration	Relocate the player away from shock or vibration
CD skips while playing	Battery becomes exhausted	Fully recharge the built-in rechargeable battery.
Cannot pair with Bluetooth speaker	The unit is not in Bluetooth (TX) mode	Switch to Bluetooth (TX) mode
	No power is turned on is Bluetooth speaker or headphone	Turn Power on the Bluetooth speaker or headphone

DISPOSAL

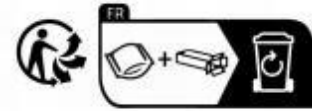
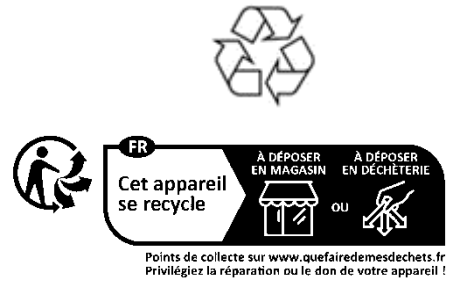
- Coopers of Stortford use Recyclable or recycled packaging where possible.
- Please dispose of all packaging, paper, cartons in accordance with your local authority recycling regulations.
- At the end of the product’s lifespan please check with your local council authorised household waste recycling centre for disposal.
- Plastics, polybags – this is made from the following recyclable plastic.
- At the end of the product’s lifespan please check with your local council authorised household waste recycling centre for disposal.



Code & Symbol	
Type of Plastic	Please Specify (include s ABS, Nylon)

Distributed by / Verteilt durch / Distribué par.

UK:
 The Enterprise Department Ltd.
 11 Bridge Street, Bishops Stortford
 Herts, UK, CM23 2JU
 Tel: 0330 331 0300
 NI/EU:
 D.S.B. LD, 160 Bd. de Fourmies, 59100 Roubaix, France
 Tel: (+44) 1279 701269
 DE/FR/CZ/SK:
 hergestellt für 3Pagen
 Sankt-Joeris-Strasse 16-28
 53477 Alsdorf
 Tel: +49(0)2404/980-204
kontakt@3pagen.de

